

Drive Systems

Geared Motors,
Motors and
Electronic Drives.

- High efficiency (IE2, IE3)
- High dynamic
- Compact design
- Low noise
- Low backlash

**watt
drive** [®]
WEG Group

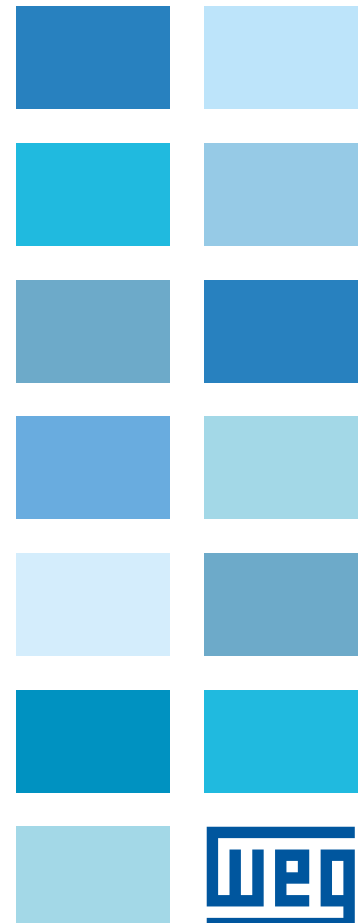
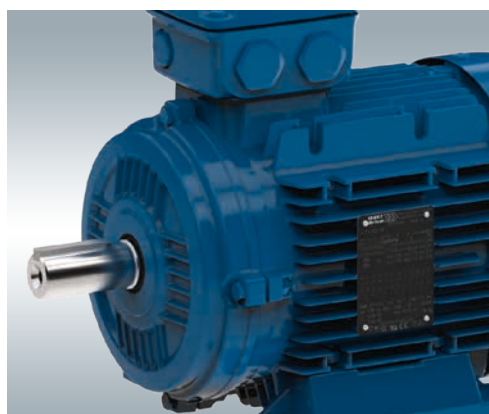
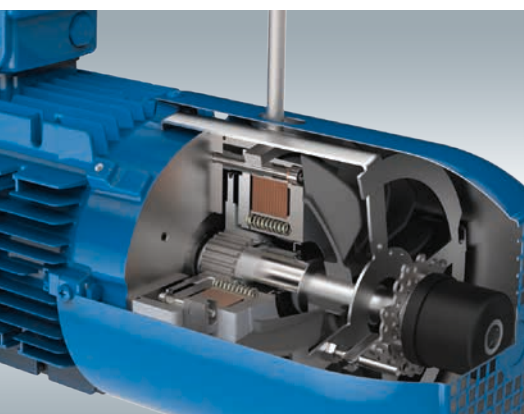
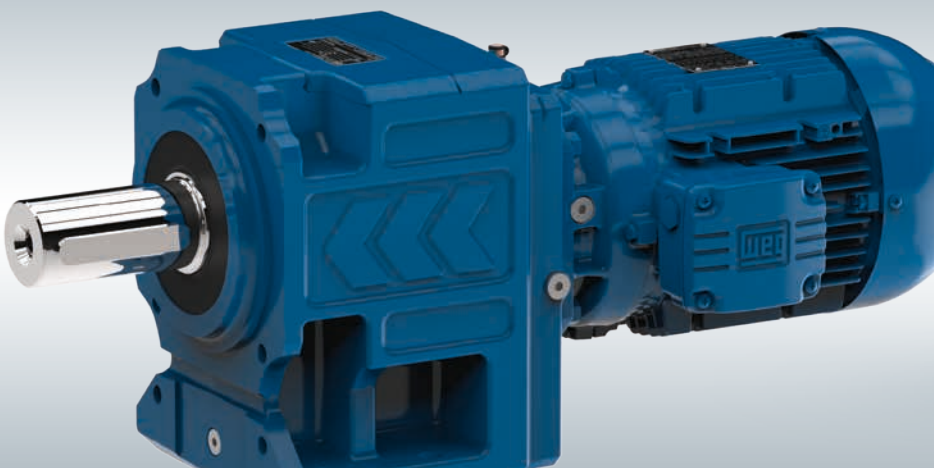

A suitable drive solution for each application

Requirements

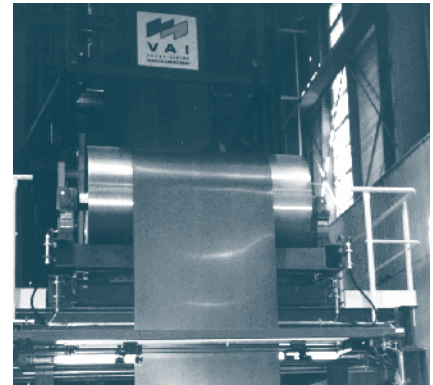
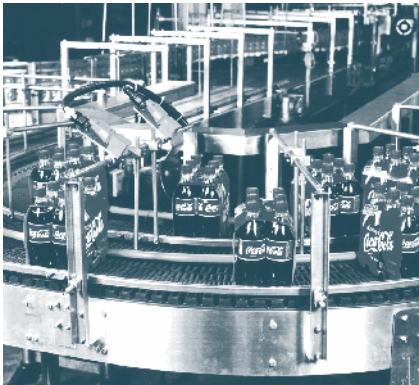

Modular Drive System WATT MAS®

Drive Systems

Gear units, motors and electronic drives

Drive Electronics

Frequency inverters, soft starters, control and display devices

Motor System

Integral motors, motor modules, IEC standard motors

Gear System

Helical, parallel shaft, shaft mounted, helical bevel, helical worm gear units

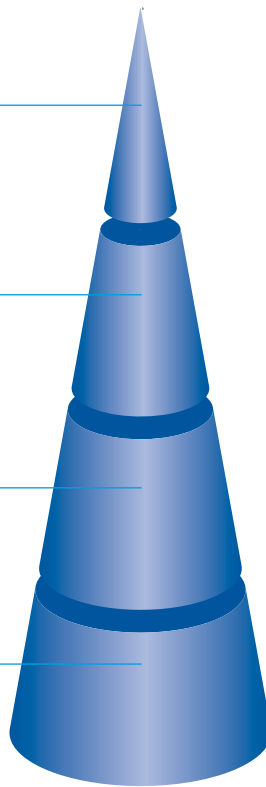

Challenging requirements.
Optimum solutions.



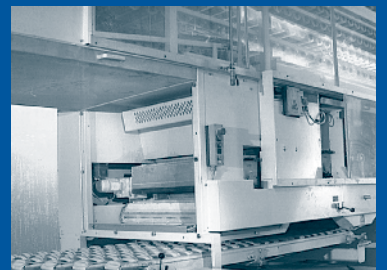
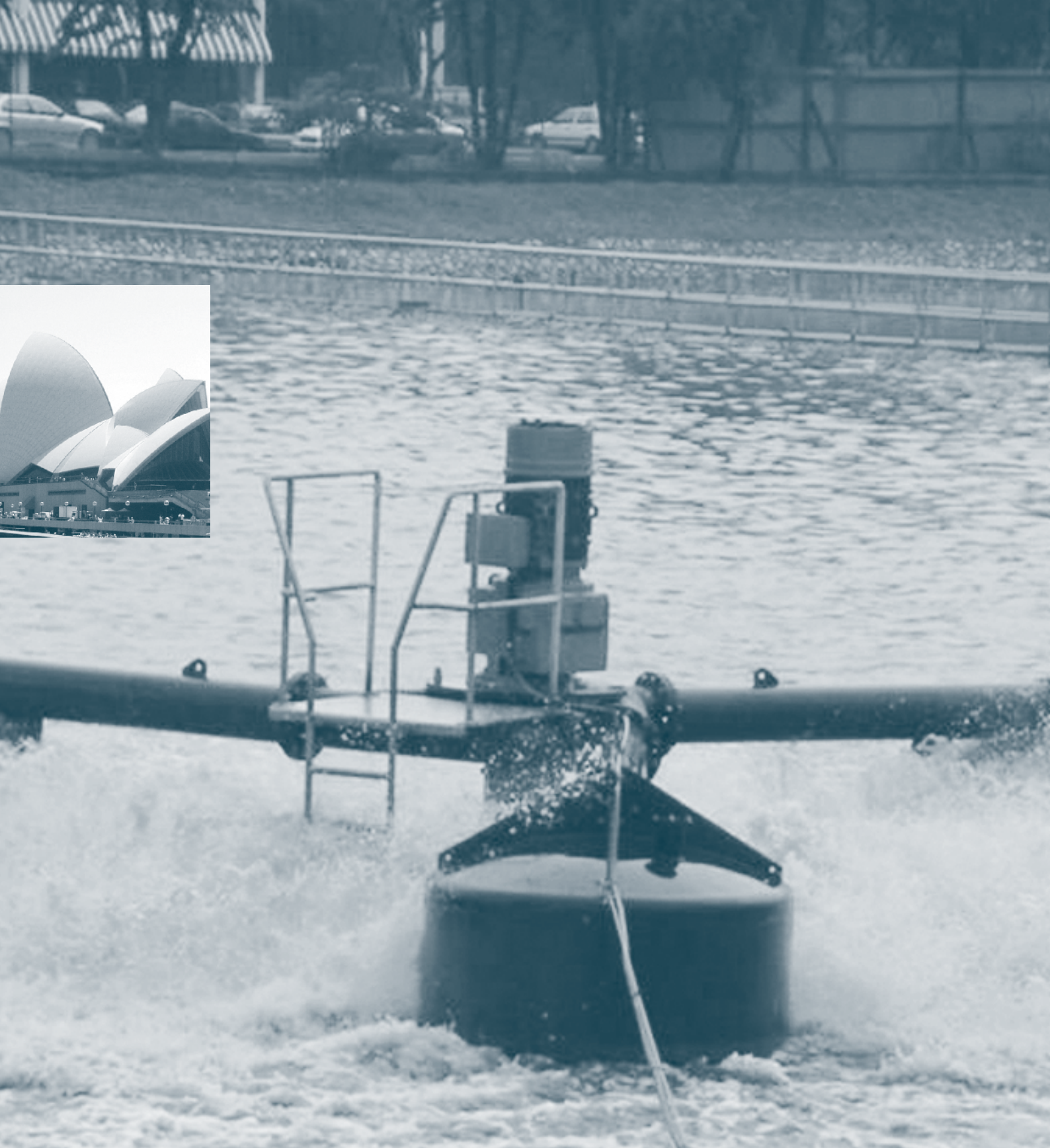

Watt Drive Systems

Solutions



Cyclical system

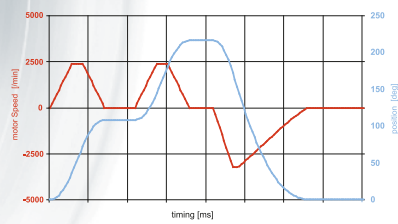
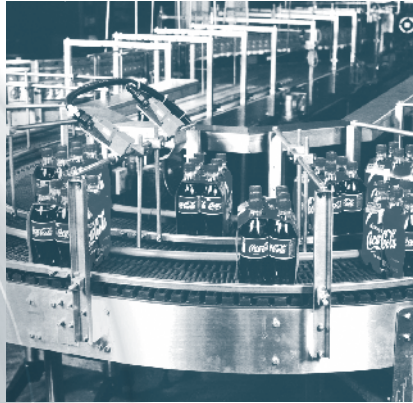

Torque follower

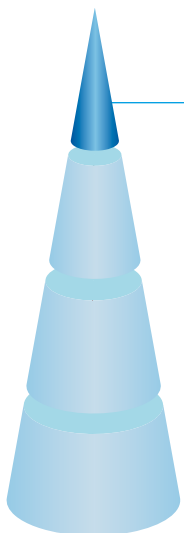
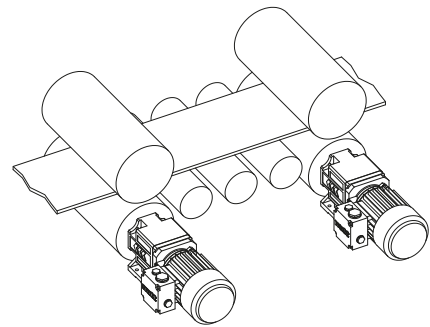
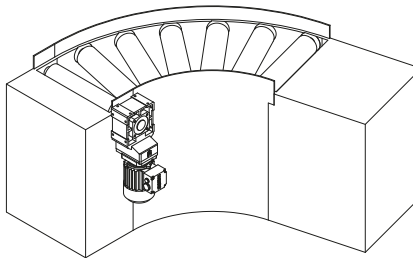
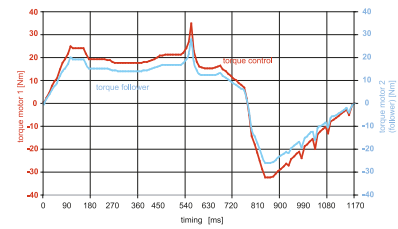
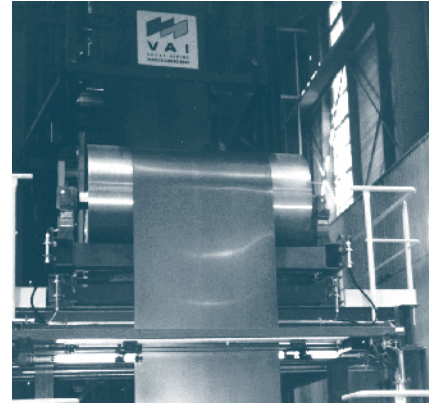

Drive Systems
Gear units, motors and
electronic drives



High starting torque



Mechanical brake control



Squared torque characteristics

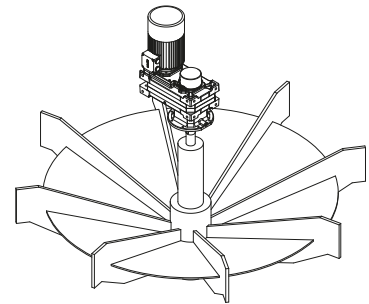
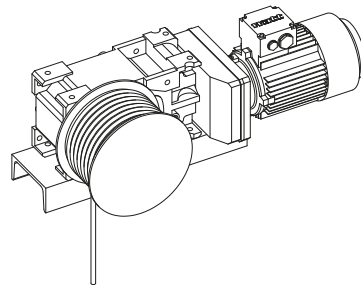
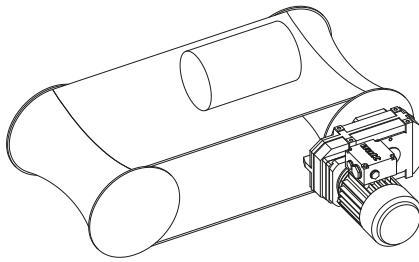
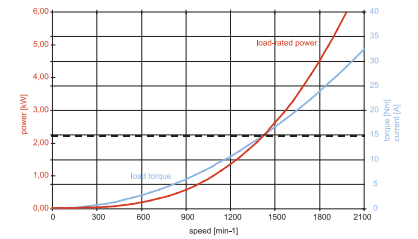
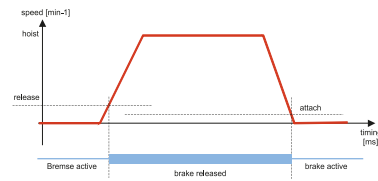
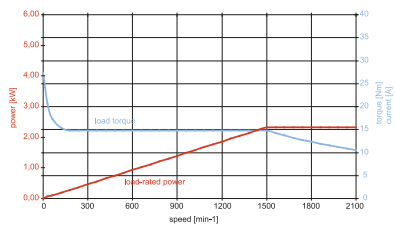
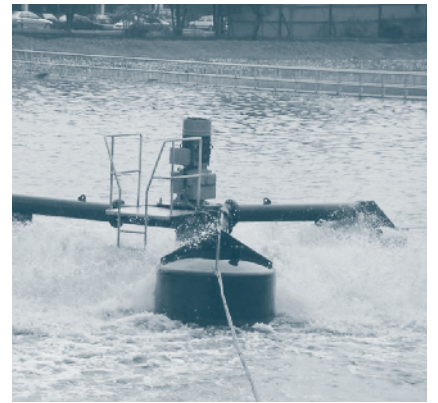

The Runners

System motors

A Motor for 100 Hz Characteristics and any Voltage Worldwide

WATT EUSAS® motors are top quality, three-phase AC industrial motors from Watt Drive's customer-oriented motor system. **EUSAS®** stands for **EU**rope - **US** - **AS**ia and means that the wide voltage range and simple voltage selector in the terminal box enable the motor to be operated with virtually any supply voltage and frequency worldwide.

100 Hz Characteristic - Double Power

In frequency inverter operation WATT EUSAS® motors can be controlled using the 87/100 Hz voltage/frequency characteristic without special windings. As a result, the same motor size can output up to double the power without being overloaded.

Connection Modes

The Watt Drive quality motor uses a 9-pin terminal block and therefore can be switched in star, delta, double star and double delta with its wide-range winding. This way, the motor still covers a large part of worldwide supply voltages.

EUSAS® motors up to incl. frame size 100 can be operated in the following voltage range: 220-240V (D), 110-120V (DD), 380-420V (Y) and 190-210V (YY). From frame size 112 following voltage ranges are possible: 380-420V (D), 190-210V (DD), 660-690V (Y) and 330-365V (YY) each for 50 and 60Hz.

EUSAS® Benefits at a Glance

- Wide-range winding from 3x190V up to 3x690V at 50/60 Hz with 9 terminals
- 100 or 87 Hz characteristic in frequency inverter operation
- Switchable voltage
- High efficiency to IE2, IE3
- Low weight
- Tropic-proof insulation system
- Operating temperature -20°C to +40°C
- Nameplate with 50/60 Hz data
- Reinforced bearings at type WAR
- Rotor shaft prepared for mounting brakes, encoders, backstops etc.
- Protection Class IP55
- Insulation Class F

Modular Motor System

The WATT Drive system motor guarantees quick and economic availability in all possible units due to its sophisticated components:

- Motors for special voltages, power and frequencies
- Brake motors
- Motors with encoders, backstops, forced cooling or without fans
- Modular terminal boxes and connect concept

Together with our frequency inverters, the motors constitute a perfectly balanced drive system.

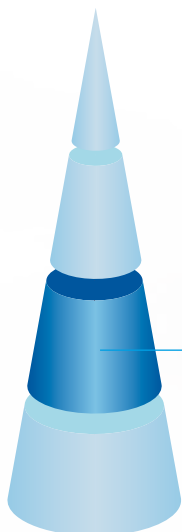

Modular Motor System
Integral motors,
motor modules,
IEC standard motors

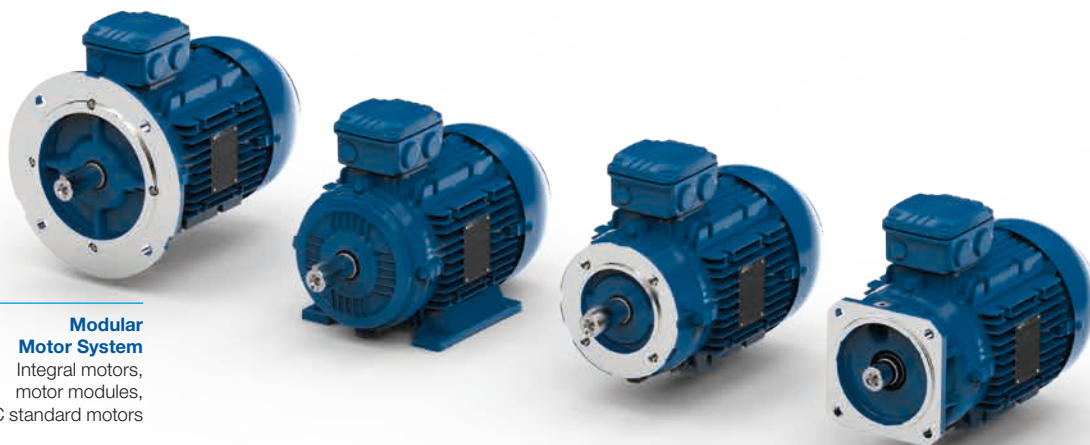

WATT - System Motors

Our Modular Motor System

System motors

WATT - EUSAS® - Motors

Design	WAG (B3), WAF (B5), WAC (B14), WAR (B5-special)
IEC size	63 - 315
Possible number of poles	2-, 4-, 6-pole
Performance area	0.12 - 200 kW

Modular Motor System

The advantage of this system offers fast and reliable delivery times for local but also international customers. The availability of all components is guaranteed through the global competent WATT / WEG sales and service network.

Examples from the modular motor system:

- 1 - Motor with special connect system (MIG-Box)
- 2 - Motor with special terminal box (MIP-Box)
- 3 - Motor with encoder (outside the fan cover)
- 4 - Brake motor nonventilated with double brake and encoder
- 5 - Brake motor with manual release and resolver
- 6 - Brake motor with encoder and forced cooling
- 7 - Brake motor with manual release, locking device and second shaft end

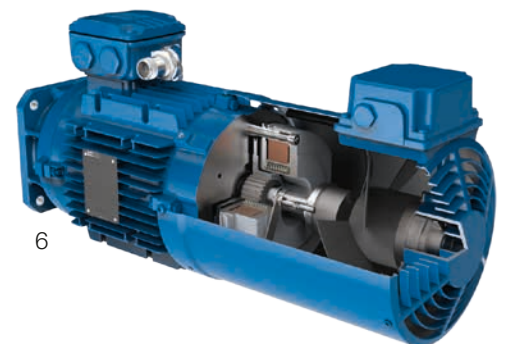
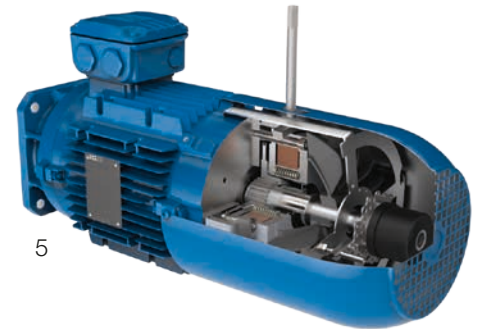
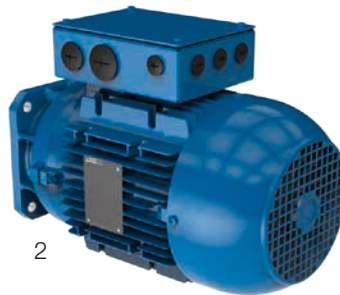

The Power Makers

Geared motors

Top Quality Geared Motors

Watt Drive geared motors are the electro-mechanical key elements for low backlash, smoothly running and highly dynamic drive systems. Our high-performance gear units are built to withstand the toughest industrial applications.

The gear housings are machined on all sides and permit diverse mounting positions and applications, making them much sought after in the industry. As a result our geared motors are often to be found as part of our customers own machines.

The smooth running of Watt Drive gear units and the outstanding load capacity of WATT teeth are achieved with 3D design supported by FEM (Finite Element Method). This tooth geometry guarantees optimum rolling contact under load.

The special tooth root design in combination with tooth helix angle, tooth depth, the materials used and surface finish maximizes load capacity. This high gearing capacity enables smaller wheels to be used for the same torque, and smaller gears with exceptional power density also increase reliability. Watt Drive geared motors are consequently incredible space savers.

Gearing manufactured with such micro-geometric precision allows the gearing play required for troublefree rolling contact to be substantially reduced and therefore the gear backlash to be minimized.

Double chamber shaft seals developed by Watt Drive are used as standard in parallel shaft, shaft mounted and helical worm gears for a high level of tightness.

We Meet Individual Customer Specifications

The innovative Watt Drive modular gear system consists of a minimum number of different parts. Intelligent part design enables them to be used in various types of gear units. Individual customer specifications can therefore be met efficiently in a short space of time.

Watt Drive's modular gear technology meets the requirements of advanced drive systems:

- Excellent power density
- Minimum backlash
- Smooth running
- Diverse mounting options
- Maximum reliability
- High variability

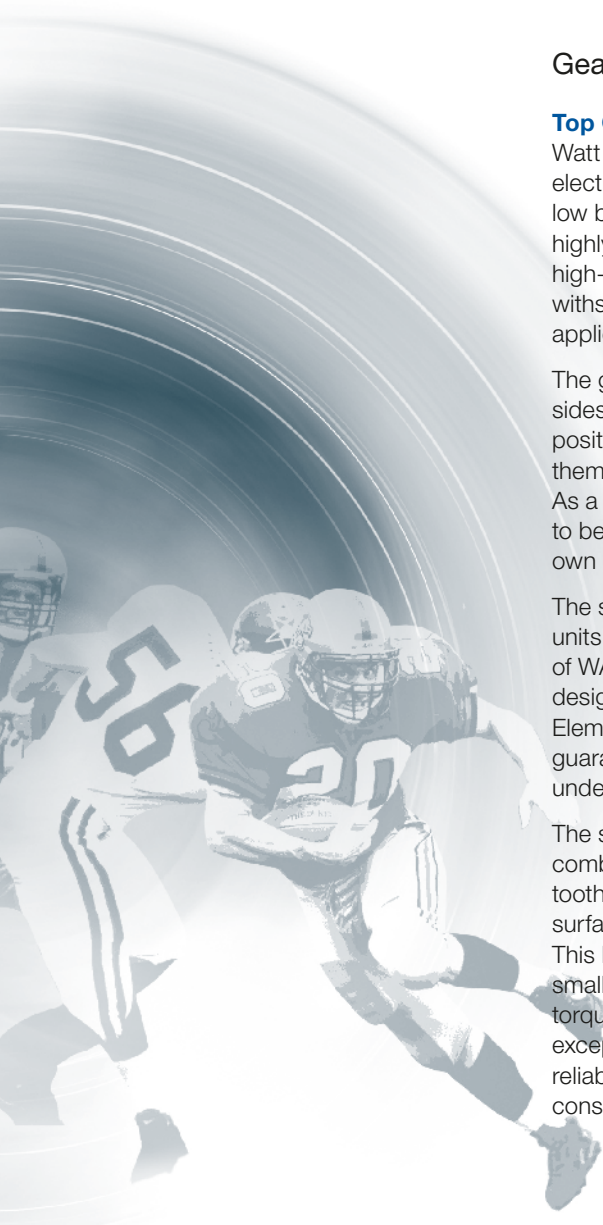

Modular Gear System

Helical, parallel shaft, shaft mounted, helical bevel, helical worm gear units

Watt Drive - The Architects of Reliable Geared Motors

Geared motors

Quality Assurance - Products All Manufactured In-house

The production of the components for our geared motors is 100 per cent vertically integrated. The latest plant and machinery and a quality management system certified to ISO 9001 maximize customer benefit by delivering high flexibility, extreme precision and outstanding reliability.

Watt Drive has thus earned itself a reputation for building rugged, virtually indestructible geared motors.

WATT MAS® Helical Geared Motor

Power: 0.12 - 55 kW
Torque: 100 - 14,000 Nm
Ratio: 2.4 - 13,500

UNIBLOCK® design for foot and flange mounting. Gear housing machined on all sides for universal application. Optimized gearing geometry here and in all the other models results in exceptional running smoothness. For special environmental conditions the gear unit can be fitted with two shaft seals.



WATT MAS® Single Stage Helical Geared Motor

Power: 0.12 - 37 kW
Torque: 23 - 1,200 Nm
Ratio: 0.8 - 11

Wherever high drive power at small gear reduction is needed (e.g. pump industry) this gear series unfolds its advantages. Those gears have very high efficiency rates through the single-stage design, which creates energy saving drive solutions on using high-efficiency motors.

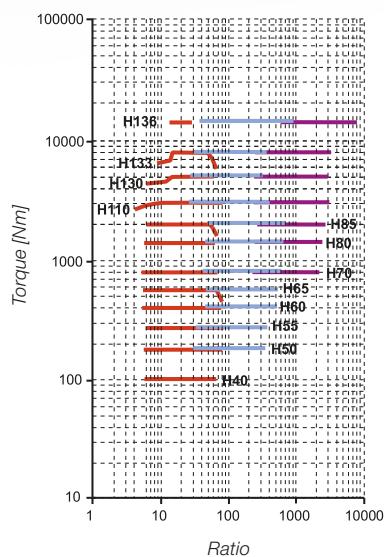

- Key:**
- Single reduction
 - Double reduction
 - Triple reduction
 - Fourstage reduction
 - Fivestage reduction

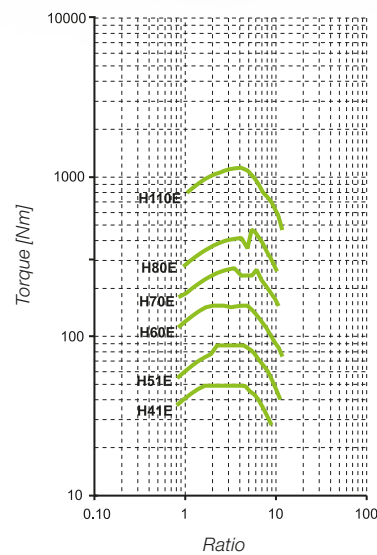

Watt Drive - The Architects of Reliable Geared Motors

Geared motors

WATT MAS® Shaft Mounted Geared Motor

Power: 0.12 - 30 kW
Torque: 27 - 2,800 Nm
Ratio: 0.8 - 4,000

In addition to the benefits of the parallel shaft geared motor, this is an extremely economical model, especially for shaft and flange mounting. Special double chamber shaft seals developed by Watt Drive are used as standard, as in the parallel shaft geared motor.

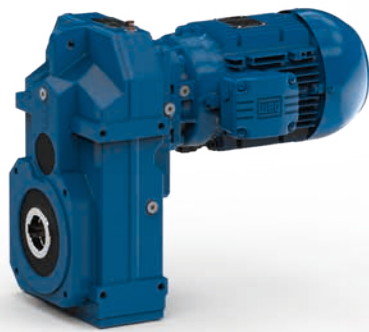

WATT MAS® Parallel Shaft Geared Motor

Power: 0.12 - 55 kW
Torque: 5,000 - 14,000 Nm
Ratio: 4 - 18,800

The UNIBLOCK® gear housing machined on all sides, the particularly stable housing and minimum outside dimensions enable diverse mounting options and applications. As a result, these motors often form an integral part of our customers machine designs. High precision manufacturing and top gearing quality guarantee minimum backlash in Watt Drive gear units.

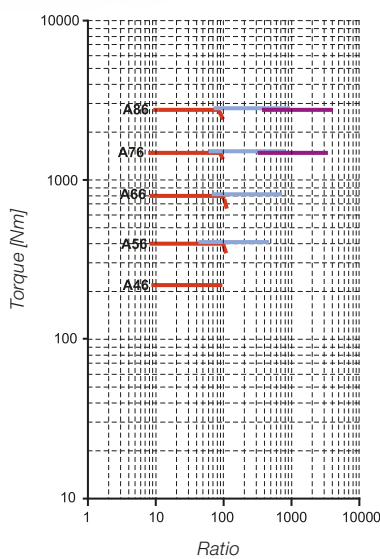
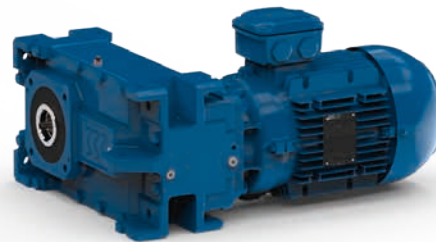

Key:

- Single reduction
- Double reduction
- Triple reduction
- Fourstage reduction
- Fivestage reduction

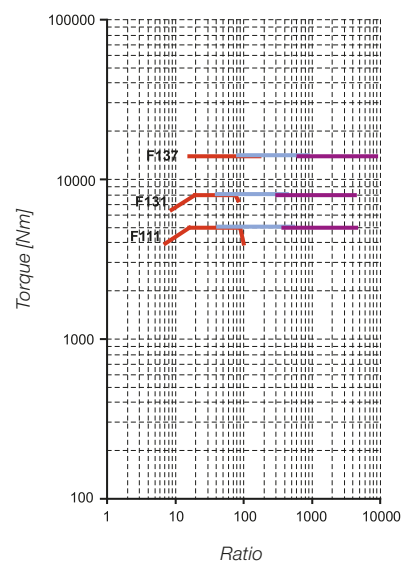

WATT MAS®
Helical Bevel Geared Motor

Power: 0.12 - 90 kW
Torque: 100 - 20,000 Nm
Ratio: 5.5 - 8,600

The compact and structure optimized gear housing of the helical bevel gears distinguish themselves by being machined on all sides and are therefore, ready for a variety of mounting options and applications. The unique motor position provides an almost flat and easy to mount on "machine interface". Various standard shaft executions and the double chamber shaft seals, developed by Watt Drive, are ready for use. Shaft and flange dimensions are equal to our helical worm geared motors.



WATT MAS®
Helical Worm Geared Motor

Power: 0.12 - 7.5 kW
Torque: 50 - 1,300 Nm
Ratio: 3 - 3,400

Due to the unique combination of optimized worm wheel material with special lubricants, optimized shape, this powerful motor achieves high levels of efficiency and torque. The housing machined on all sides enables diverse mounting options. Double chamber shaft seals are used as standard. The low contour design makes it suitable for implementing applications e.g. in the food industry. The housing has no recesses, which simplifies cleaning - a particularly essential feature for areas with stringent hygiene requirements.

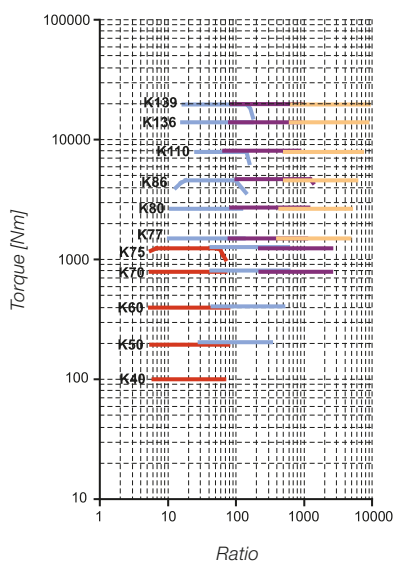
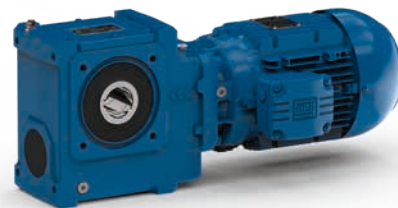

- Key:**
- Single reduction
 - Double reduction
 - Triple reduction
 - Fourstage reduction
 - Fivestage reduction

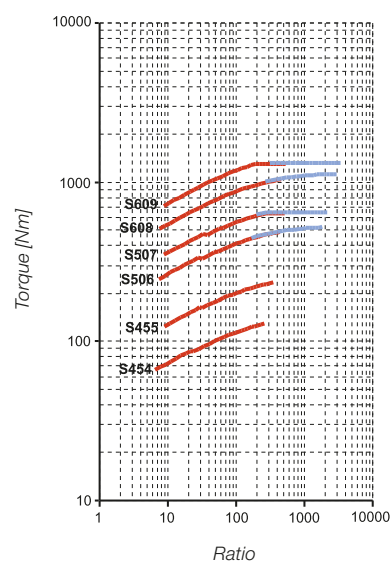

Modular Drive System

Drive System

A modular system that satisfies every requirement

Watt Drive's remarkable geared motor program offers manifold possible variations and motor options that can fulfill all customers requirements.

Assembly and attachment variants

It goes without saying that the Watt Drive system provides for all the conventional means of attachment, such as flange-mounts, foot-mounts and torque arms. The special feature of this WATT product is its UNIBLOCK® design: the housing is machined on all sides, which further increases the number of possible assembling variants.

Adapter kit

WATT adapters provide a very simple „dry“ way of attaching standard IEC or NEMA motors, servomotors or special motors to Watt Drive's gear systems. Many special motors (servos) can be attached directly to Watt Drive gear systems without any unwieldy additional mass, a highly efficient method particularly for high-speed applications. The input shaft unit can be used to run the drive via a belt or flexible coupling.

Frequency inverter program

WEG's frequency inverter program CFW11(M), CFW700, CFW500, CFW100 - ranging from 0.18 to 450 kW (2,000 kW) - are a consistent extension of the principle of modular drive system assembly kits. These frequency inverters are remarkable for their excellent regulator properties, compact form, ease of operation and intelligent controls.

Shaft

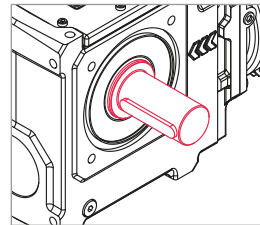

Output shaft

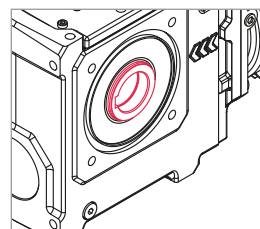

Hollow shaft

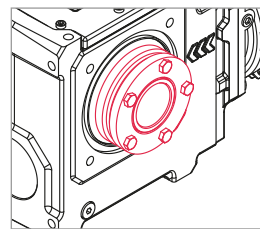

Hollow shaft + Shrink disc

Assembly, Mounting

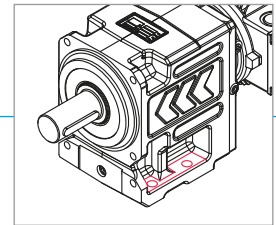

Foot

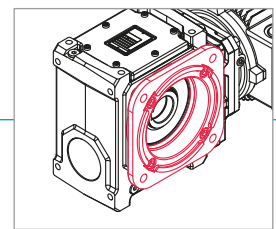

Flange

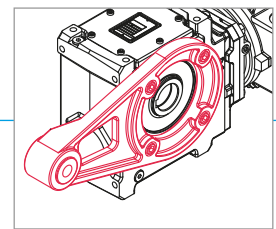

Torque arm

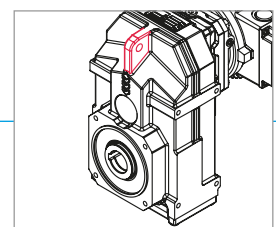

Shaft mounted type

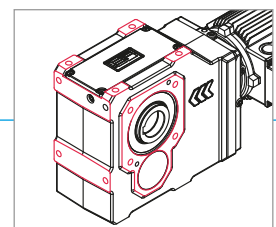

UNIBLOCK® type

Gear Type



Helical gear unit



Shaft mounted gear unit

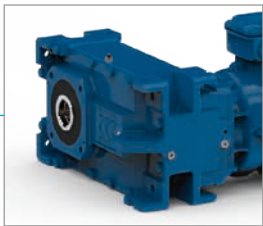

Parallel shaft gear unit



Helical bevel gear unit



Helical worm gear unit

Input Types

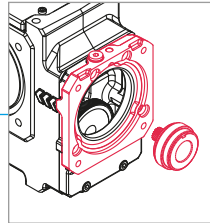

Direct mounting

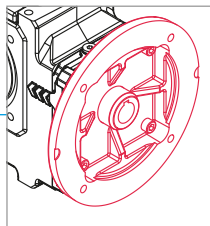

IEC, NEMA adapter

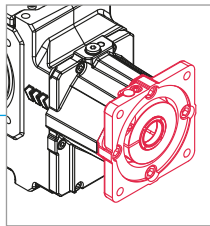

SERVO adapter

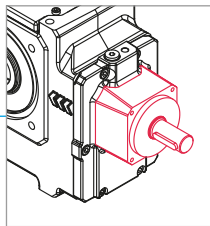

Input shaft unit

Integral Motor

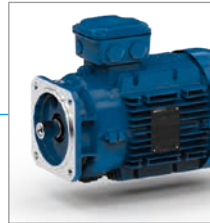

WAR

IEC MOTORS



WAF (B5)



WAG (B3)



WAC (B14)

Modular Motor System

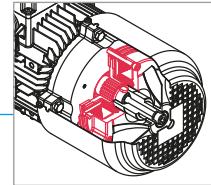

Brake

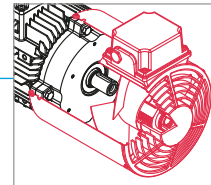

Forced cooling

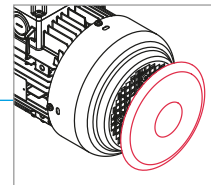

Protection cap

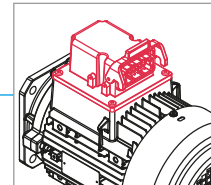

Connection / Switches

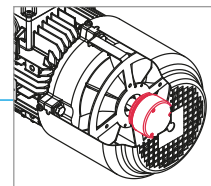

Encoder systems

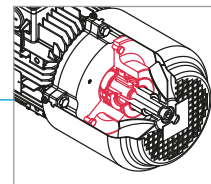

Backstop

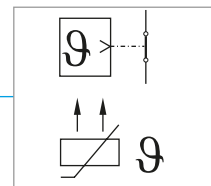

Motor protection

Electronic Drives



CFW11



CFW700



CFW500



CFW100

Our Drive - Your Solution

Environmental industry

Applications for outdoor and/or aggressive environments (such as sewage treatment or biogas plants) call for special measures to ensure years of reliable operation for the drives used: special varnishes and coatings, protective caps, anti-condensation heating, rust-proof brake systems.



Steel industry

Day-to-day operations in the steel industry involve extreme impact stresses, the need to accelerate enormous masses, in red-heat temperatures. The drive system used have to be reliable and require little maintenance.

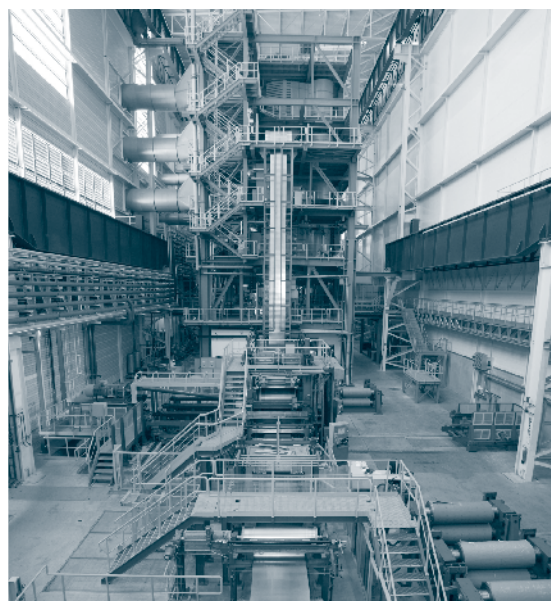

Theatre and stage technology

The noise emitted from the installed drive technology may not interfere with operations in the theatre at all. The authorized noise levels are in accordance with the corresponding norms and have to, on all accounts, be observed.



Materials-handling technology

“Strong” and “safe” are the principle requirements for materials handling technology. Full gantry cranes, level luffing and slewing cranes, screening machines and conveyors all have to handle extreme loads reliably for many years.



Aerial cableway technology

Aerial cableway transportation is subject to the most stringent specifications and standards, which all have to be reliably fulfilled by the drive technology used. Thanks to our ISO 9001:2000 quality management, our standard is consistently at this high level.

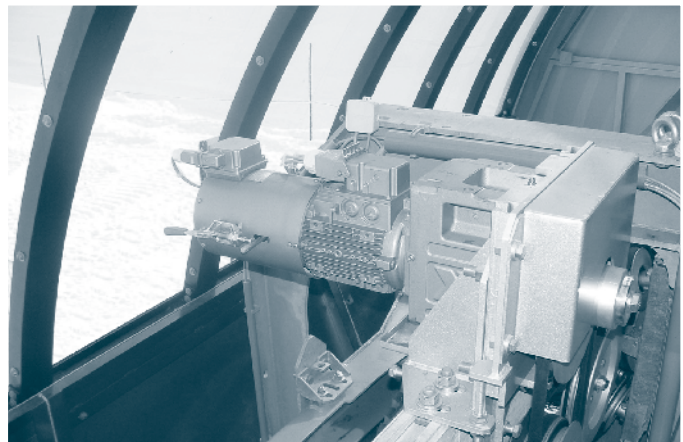

Mineral processing industry

The manufacture of asphalt concrete at a location with rough environment conditions calls for maximum process safety – from -40° to $+60^{\circ}\text{C}$. Drives for such extreme ambient conditions also require various additional options (e.g. seals, etc.).



Watt Drive Antriebstechnik GmbH
Wöllersdorfer Straße 68
2753 Markt Piesting, AUSTRIA
Phone: +43 (0) 2633 404-0
info-at@weg.net
www.wattdrive.com